



MTM Series

PCB mount ultra-compact, regulated, high voltage DC-DC converter – Flat mounting

	<ul style="list-style-type: none">- 96 standard products- References : see chart for complete reference- 4 output voltage ranges: (Vout): 0 to 600V, or to 1kV or to 1,25kV or to 1,5kV- Nominal power: 0,5W, 0,8W and 1W- 3 input voltage ranges (Vin): 12Vdc, 15Vdc or 24Vdc- Main applications : Photomultiplier Tubes (PM), Avalanche Photodiodes, etc...	
--	--	---

General Description

The MTM Series is the ideal solution for PMTs and other devices which need a bias voltage ranging from 0 to 1500V

Miniature and lightweight	Tight line/load regulation	Arc and continuous short circuit protection
Horizontal case when low profile needed	Voltage monitoring	Low ripple (<0.003%)
RoHS	Potted in an UL epoxy resin	Option: flying lead for the HV output

Parameters	Specifications
Input voltage Vin (pins 1 & 2)	12Vdc \pm 0.5 or 15Vdc \pm 0.5 or 24Vdc \pm 1, according to the model.
Input current	At no load: 15mA. At full load, from to 65mA to 100mA, according to the input voltage.
HV output Vout (pin 7 or flying lead optional)	Programmable nominal voltage, refer to the Selection Guide for voltage ranges, accuracy: \pm 0.2% at the max voltage.
Output voltage polarity	Fixed positive or negative, according to the model
Output voltage setting (pins 3, 4 & 5)	Option 1: via an external potentiometer, minimum 10k Ω (use Ref. Voltage pin 5). Option 2: via an external voltage 0/5V or 0/10V, according to the model. Note: input impedance of the control input (pin 4) = 1M Ω .
Max. output current Iout	Refer to the Selection Guide.
Load Voltage regulation	\pm 0.01% of the full output voltage, no load to full load.
Line Voltage regulation	\pm 0.01% of the full output voltage over the specified input voltage range.
Ripple	Between 10mV to 40mVpeak-to-peak at full load, according to the model.
Temperature coefficient	100ppm/ $^{\circ}$ C over the temperature range 0 to 50 $^{\circ}$ C.
HV monitoring output (Vmon) (pin 6)	+1V/kV or -1V/kV according to the polarity of the model, accuracy: \pm 2%, output impedance = 200M Ω , TC= 100ppm/ $^{\circ}$ C (passive voltage divider).
Reference Voltage (pin 3)	-option 1 : 5V , -option 2 : 10V, accuracy : \pm 0.05%, TC 50ppm/ $^{\circ}$ C, max output current : 1mA.
Operating temperature range	-40 $^{\circ}$ C to +50 $^{\circ}$ C.
Storage temperature range	-40 $^{\circ}$ C to +70 $^{\circ}$ C.
Safeguards	- Arc and short circuit protection. - Protected against reverse Vin.
Option	-Flying lead for the HV output instead of the pin 7 (suffix "L").

	<p>SDS HIGH VOLTAGE 18 avenue Raspail 94100 SAINT MAUR DES FOSSES -France +33(0)1 48 76 88 45 contact@sdshv.com www.sdshv.com</p>	<p>Rev 1 – March 21</p>
---	---	-------------------------

MTM Series

PCB mount ultra-compact, regulated, high voltage DC-DC converter – Flat mounting

Package Configuration

Case material	Tin steel plate Thickness 0.5mm
Case dimensions	L 46.0 x W 12.0 x 24.6mm
Pins	Through round pins, diameter: 0.46mm, length: 3mm, spacing: 2.54mm. Option: flying wire for the HV output
PCB mounting	4 mounting rabs, length: 5mm, thickness: 0.5mm
Weight	35g
Insulation	Fully potted with an UL epoxy resin

Pins' function

Line input	#1: Supply #2: 0V supply
HV setting	#3: 0V signal #4: Control input #5: Voltage reference
HV monitor	#6: Voltage monitor
HV output	#7: output

Fonctional diagram

Example of use with a DAC as a setting method:

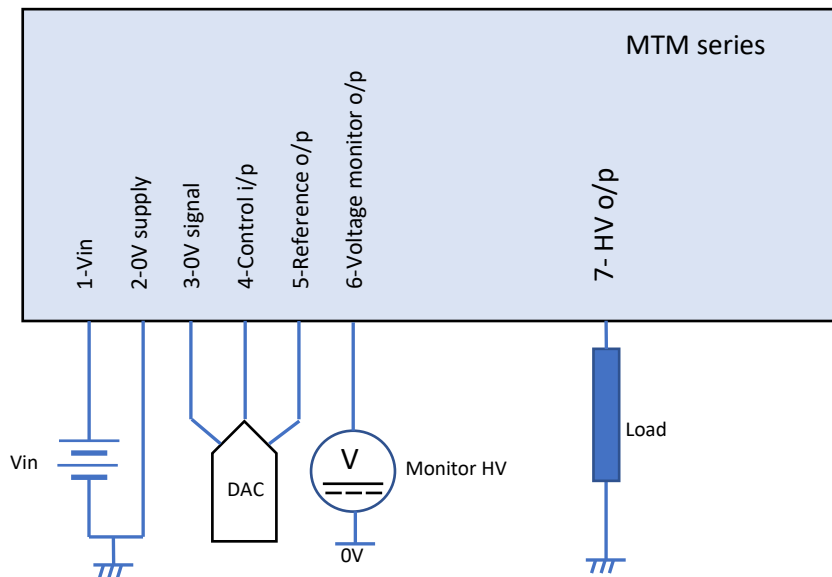

Notes for best performance:

- HV return should be connected to pin 2,
- power ground and signal ground should be separated (pin 2, pin 3 & case are internally connected).



SDS HIGH VOLTAGE
18 avenue Raspail
94100 SAINT MAUR DES FOSSES -France
+33(0)1 48 76 88 45
contact@sdshv.com
www.sdshv.com

Rev 1 – March 21

MTM Series

PCB mount ultra-compact, regulated, high voltage DC-DC converter – Flat mounting

Mechanical details

Bottom view

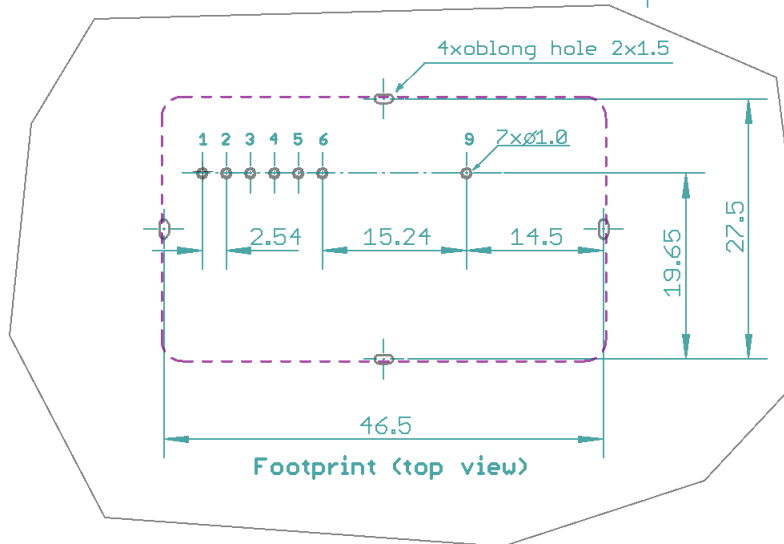
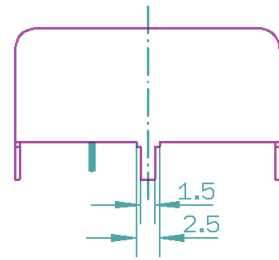
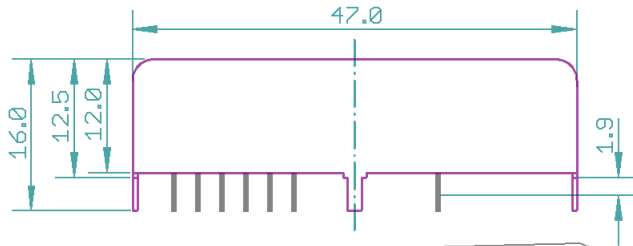

All dimensions are in mm.



European projection

Mouting of the optional wire:

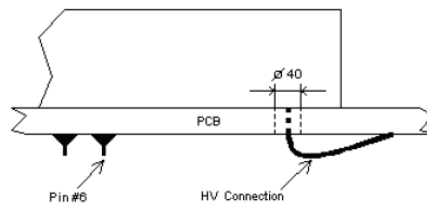

SDS HIGH VOLTAGE
18 avenue Raspail
94100 SAINT MAUR DES FOSSES -France
+33(0)1 48 76 88 45
contact@sdsHV.com
www.sdsHV.com

MTM Series

PCB mount ultra-compact, regulated, high voltage DC-DC converter – Flat mounting

Ordering information

Series	MT series Flat mounting	MTM
Input	12VDC nominal	12
	15VDC nominal	15
	24VDC nominal	24
Polarity	Positive output voltage	P
	Negative output voltage	N
Output	0 to 1500VDC	1.5
	0 to 1250VDC	1.25
	0 to 1000VDC	1
	0 to 600VDC	0.6
Power	1W nominal for all 24V input models	1
	0.8W nominal for all 15V input models	0.8
	0.5W nominal for all 15V input models	0.5
Control & Voltage reference	0 to 5VDC	C5
	0 to 10VDC	C10
HV connector	Pin 7 (standard)	Void
	A flying wire (L. 50cm, diam 2mm) replaces the pin 7 (option).	L

Other models are possible on demand.

Example of ordering reference:

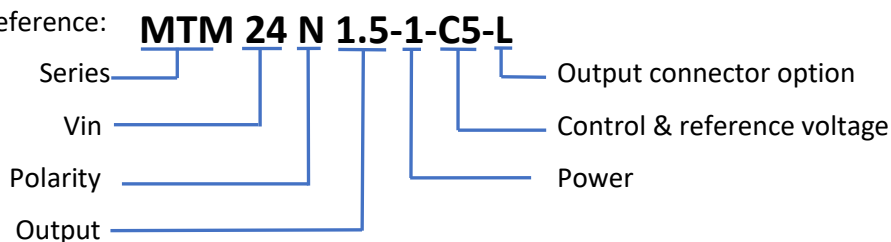

MTM series selection guide

#	Obsolete reference system	Current reference system	Vout	Polarity	Iout/Pout	Vin	Control	Otpion
#1	MT12N601831-5F	MTM12N0.6-0.5-C5	600V	-	0.83mA/0.5W	12V	5V	Pin
#2	MT12N601831-10F	MTM12N0.6-0.5-C10		-			10V	Pin
#3	MT12N601831-5F-W	MTM12N0.6-0.5-C5-L		-			5V	Wire
#4	MT12N601831-10F-W	MTM12N0.6-0.5-C10-L		-			10V	Wire
#5	MT12P601831-5F	MTM12P0.6-0.5-C5		+			5V	Pin
#6	MT12P601831-10F	MTM12P0.6-0.5-C10		+			10V	Pin
#7	MT12P601831-5F-W	MTM12P0.6-0.5-C5-L		+			5V	Wire
#8	MT12P601831-10F-W	MTM12P0.6-0.5-C10-L		+			10V	Wire
#9	MT15N601132-5F	MTM15N0.6-0.8-C5	-	1.33mA/0.8W	15V	5V	Pin	
#10	MT15N601132-10F	MTM15N0.6-0.8-C10	-			10V	Pin	



SDS HIGH VOLTAGE
 18 avenue Raspail
 94100 SAINT MAUR DES FOSSES -France
 +33(0)1 48 76 88 45
contact@sdshv.com
www.sdshv.com

Rev 1 – March 21

MTM Series

PCB mount ultra-compact, regulated, high voltage DC-DC converter – Flat mounting

#11	MT15N601132-5F-W	MTM15N0.6-0.8-C5-L	600V cont'd	-	1.33mA/0.8W	15V cont'd	5V	Wire	
#12	MT15N601132-C10W	MTM15N0.6-0.8-C10-L		-			10V	Wire	
#13	MT15P601132-5F	MTM15P0.6-0.8-C5		+			5V	Pin	
#14	MT15P601132-10F	MTM15P0.6-0.8-C10		+			10V	Pin	
#15	MT15P601132-5F-W	MTM15P0.6-0.8-C5-L		+			5V	Wire	
#16	MT15P601132-10F-W	MTM15P0.6-0.8-C10-L		+			10V	Wire	
#17	MT24N601167-5F	MTM24N0.6-1-C5		-	1.67mA/1.0W	24V	5V	Pin	
#18	MT24N601167-10F	MTM24N0.6-1-C10		-			10V	Pin	
#19	MT24N601167-5F-W	MTM24N0.6-1-C5-L		-			5V	Wire	
#20	MT24N601167-10F-W	MTM24N0.6-1-C10-L		-			10V	Wire	
#21	MT24P601167-5F	MTM24P0.6-1-C5		+			5V	Pin	
#22	MT24P601167-10F	MTM24P0.6-1-C10		+			10V	Pin	
#23	MT24P601167-5F-W	MTM24P0.6-1-C5-L		+			5V	Wire	
#24	MT24P601167-10F-W	MTM24P0.6-1-C10-L		+			10V	Wire	
#25	MT12N102501-5F	MTM12N1-0.5-C5		1000V	-	0.50mA/0.5W	12V	5V	Pin
#26	MT12N102501-10F	MTM12N1-0.5-C10			-			10V	Pin
#27	MT12N102501-5F-W	MTM12N1-0.5-C5-L	-		5V			Wire	
#28	MT12N102501-10F-W	MTM12N1-0.5-C10-L	-		10V			Wire	
#29	MT12P102501-5F	MTM12P1-0.5-C5	+		5V			Pin	
#30	MT12P102501-10F	MTM12P1-0.5-C10	+		10V			Pin	
#31	MT12P102501-5F-W	MTM12P1-0.5-C5-L	+		5V			Wire	
#32	MT12P102501-10F-W	MTM12P1-0.5-C10-L	+		10V			Wire	
#33	MT15N102801-5F	MTM15N1-0.8-C5	-		0.80mA/0.8W	15V	5V	Pin	
#34	MT15N102801-10F	MTM15N1-0.8-C10	-				10V	Pin	
#35	MT15N102801-5F-W	MTM15N1-0.8-C5-L	-				5V	Wire	
#36	MT15N102801-10F-W	MTM15N1-0.8-C10-L	-				10V	Wire	
#37	MT15P102801-5F	MTM15P1-0.8-C5	+				5V	Pin	
#38	MT15P102801-10F	MTM15P1-0.8-C10	+				10V	Pin	
#39	MT15P102801-5F-W	MTM15P1-0.8-C5-L	+				5V	Wire	
#40	MT15P102801-10F-W	MTM15P1-0.8-C10-L	+				10V	Wire	
#41	MT24N102102-5F	MTM24N1-1-C5	1000V	-	1.00mA/1.0W	24V	5V	Pin	
#42	MT24N102102-10F	MTM24N1-1-C10		-			10V	Pin	
#43	MT24N102102-5F-W	MTM24N1-1-C5-L		-			5V	Wire	
#44	MT24N102102-10F-W	MTM24N1-1-C10-L		-			10V	Wire	
#45	MT24P102102-5F	MTM24P1-1-C5		+			5V	Pin	
#46	MT24P102102-10F	MTM24P1-1-C10		+			10V	Pin	
#47	MT24P102102-5F-W	MTM24P1-1-C5-L		+			5V	Wire	
#48	MT24P102102-10F-W	MTM24P1-1-C10-L		+			10V	Wire	
#49	MT12N122401-5F	MTM12N1.25-0.5-C5	1250V	-	0.4mA/0.5W	12V	5V	Pin	
#50	MT12N122401-10F	MTM12N1.25-0.5-C10		-			10V	Pin	
#51	MT12N122401-5F-W	MTM12N1.25-0.5-C5-L		-			5V	Wire	



SDS HIGH VOLTAGE
18 avenue Raspail
94100 SAINT MAUR DES FOSSES -France
+33(0)1 48 76 88 45
contact@sdshv.com
www.sdshv.com

Rev 1 – March 21

MTM Series

PCB mount ultra-compact, regulated, high voltage DC-DC converter – Flat mounting

#52	MT12N122401-10F-W	MTM12N1.25-0.5-C10-L	1250V cont'd	-	0.4mA/0.5W Cont'd	12V Cont'd	5V	Wire
#53	MT12P122401-5F	MTM12P1.25-0.5-C5		+			10V	Pin
#54	MT12P122401-10F	MTM12P1.25-0.5-C10		+			5V	Pin
#55	MT12P122401-5F-W	MTM12P1.25-0.5-C5-L		+			10V	Wire
#56	MT12P122401-10F-W	MTM12P1.25-0.5-C10-L		+			5V	Wire
#57	MT15N122641-5F	MTM15N1.25-0.8-C5		-	0.64mA/0.8W	15V	10V	Pin
#58	MT15N122641-10F	MTM15N1.25-0.8-C10		-			5V	Pin
#59	MT15N122641-5F-W	MTM15N1.25-0.8-C5-L		-			10V	Wire
#60	MT15N122641-10F-W	MTM15N1.25-0.8-C10-L		-			5V	Wire
#61	MT15P122641-5F	MTM15P1.25-0.8-C5		+			10V	Pin
#62	MT15P122641-10F	MTM15P1.25-0.8-C10		+			5V	Pin
#63	MT15P122641-5F-W	MTM15P1.25-0.8-C5-L		+			10V	Wire
#64	MT15P122641-10F-W	MTM15P1.25-0.8-C10-L		+			5V	Wire
#65	MT24N122801-5F	MTM24N1.25-1-C5		-	0.80mA/1.0W	24V	10V	Pin
#66	MT24N122801-10F	MTM24N1.25-1-C10		-			5V	Pin
#67	MT24N122801-5F-W	MTM24N1.25-1-C5-L		-			10V	Wire
#68	MT24N122801-10F-W	MTM24N1.25-1-C10-L	-	5V			Wire	
#69	MT24P122801-5F	MTM24P1.25-1-C5	+	10V			Pin	
#70	MT24P122801-10F	MTM24P1.25-1-C10	+	5V			Pin	
#71	MT24P122801-5F-W	MTM24P1.25-1-C5-L	+	10V			Wire	
#72	MT24P122801-10F-W	MTM24P1.25-1-C10-L	+	5V			Wire	
#73	MT12N152331-5F	MTM12N1.5-0.5-C5	1500V	-	0.33mA/0.5W	12V	10V	Pin
#74	MT12N152331-10F	MTM12N1.5-0.5-C10		-			5V	Pin
#75	MT12N152331-5F-W	MTM12N1.5-0.5-C5-L		-			10V	Wire
#76	MT12N152331-10F-W	MTM12N1.5-0.5-C10-L		-			5V	Wire
#77	MT12P152331-5F	MTM12P1.5-0.5-C5		+			10V	Pin
#78	MT12P152331-10F	MTM12P1.5-0.5-C10		+			5V	Pin
#79	MT12P152331-5F-W	MTM12P1.5-0.5-C5-L		+			10V	Wire
#80	MT12P152331-10F-W	MTM12P1.5-0.5-C10-L		+			5V	Wire
#81	MT15N152531-5F	MTM15N1.5-0.8-C5		-	0.53mA/0.8W	15V	10V	Pin
#82	MT15N152531-10F	MTM15N1.5-0.8-C10		-			5V	Pin
#83	MT15N152531-5F-W	MTM15N1.5-0.8-C5-L		-			10V	Wire
#84	MT15N152531-10F-W	MTM15N1.5-0.8-C10-L		-			5V	Wire
#85	MT15P152531-C5	MTM15P1.5-0.8-C5		+			10V	Pin
#86	MT15P152531-C10	MTM15P1.5-0.8-C10		+			5V	Pin
#87	MT15P152531-5F-W	MTM15P1.5-0.8-C5-L		+			10V	Wire
#88	MT15P152531-10F-W	MTM15P1.5-0.8-C10-L		+			5V	Wire
#89	MT24N152671-5F	MTM24N1.5-1-C5	-	0.97mA/1.0W	24V	10V	pin	
#90	MT24N152671-10F	MTM24N1.5-1-C10	-			5V	Pin	
#91	MT24N152671-5F-W	MTM24N1.5-1-C5-L	-			10V	Wire	
#92	MT24N152671-10F-W	MTM24N1.5-1-C10-L	-			5V	Wire	



SDS HIGH VOLTAGE
18 avenue Raspail
94100 SAINT MAUR DES FOSSES -France
+33(0)1 48 76 88 45
contact@sdshv.com
www.sdshv.com

MTM Series

PCB mount ultra-compact, regulated, high voltage DC-DC converter – Flat mounting

#93	MT24P152671-5F	MTM24P1.5-1-C5	1500V cont'd	+	0.97mA/1.0W cont'd	24V cont'd	10V	pin
#94	MT24P152671-10F	MTM24P1.5-1-C10		+			5V	Pin
#95	MT24P152671-5F-W	MTM24P1.5-1-C5-L		+			10V	Wire
#96	MT24P152671-10F-W	MTM24P1.5-1-C10-L		+			5V	Wire

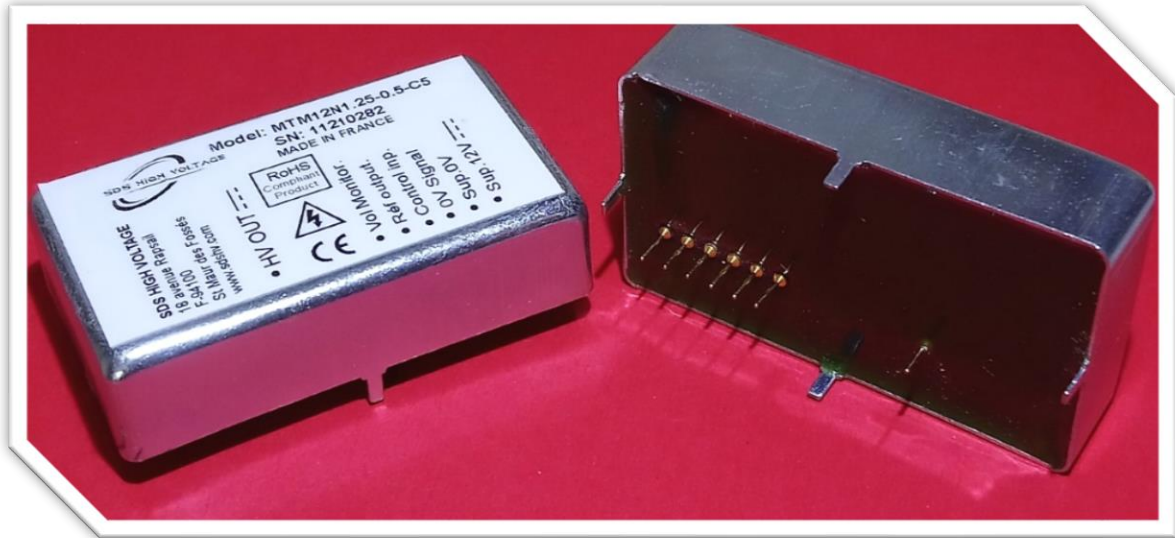

SDS HIGH VOLTAGE
 18 avenue Raspail
 94100 SAINT MAUR DES FOSSES -France
 +33(0)1 48 76 88 45
contact@sdshv.com
www.sdshv.com

Rev 1 – March 21